

TOSHIBA Photocoupler GaAs Ired & Photo-Transistor

TLP620, TLP620-2, TLP620-4

Programmable Controllers
 AC / DC-Input Module
 Telecommunication

The TOSHIBA TLP620, -2 and -4 consists of a photo-transistor optically coupled to two gallium arsenide infrared emitting diode connected in inverse parallel.

The TLP620-2 offers two isolated channels in an eight lead plastic DIP, while the TLP620-4 provides four isolated channels in a sixteen plastic DIP.

- Collector-emitter voltage: 55V (min.)
- Current transfer ratio: 50% (min.)
 Rank GB: 100% (min.)

Pin Configurations (top view)

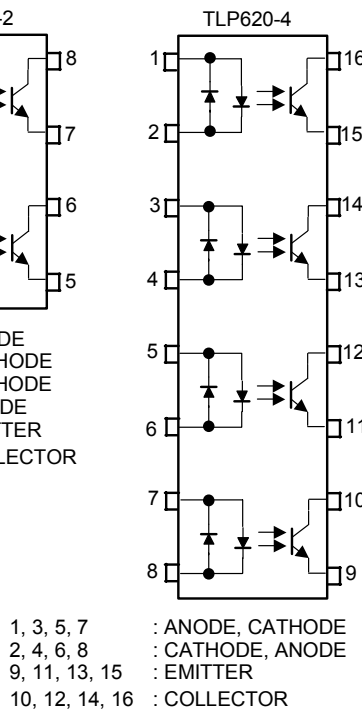
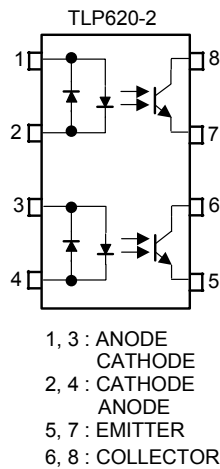
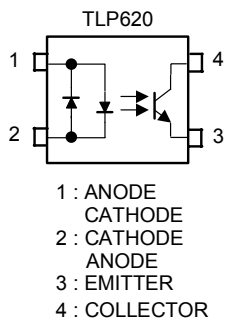

Unit in mm

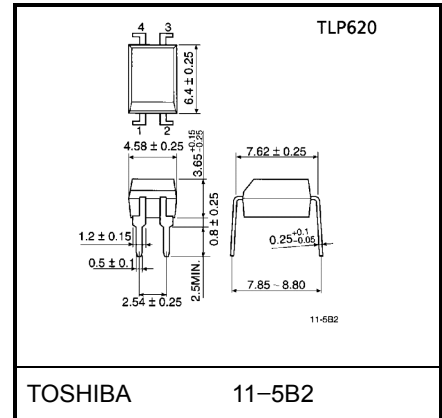

Weight: 0.26 g

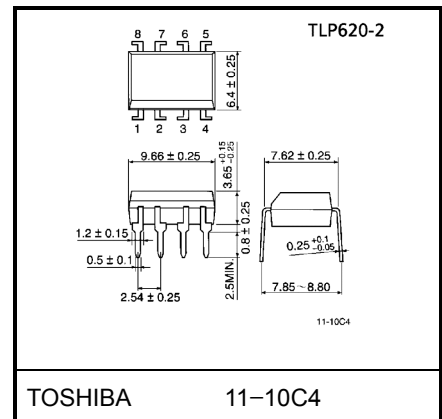

Weight: 0.54 g

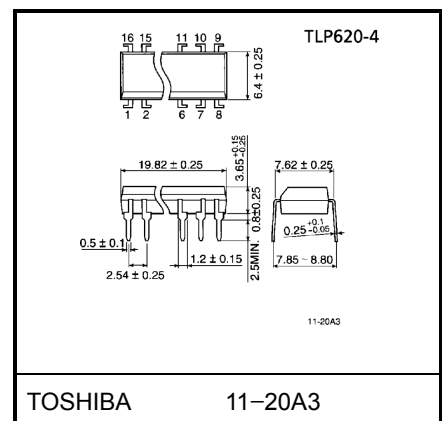

Weight: 1.1 g

	Made In Japan		Made In Thailand	
UL recognized	E67349	*1	E152349	*1
BSI approved	7426, 7427	*2	7426, 7427	*2

*1 UL1577

*2 BS EN60065: 1994, BS EN60950: 1992

- Isolation voltage: 5000V_{rms} (min.)
- Option (D4) type
VDE approved: DIN VDE0884 / 06.92, certificate no. 68384
Maximum operating insulation voltage: 890V_{PK}
Highest permissible over voltage: 8000V_{PK}

(Note) When a VDE0884 approved type is needed, please designate the "Option(D4)".

- Creepage distance: 6.4mm (min.)
Clearance: 6.4mm (min.)
Insulation thickness: 0.4mm (min.)

Maximum Ratings (Ta = 25°C)

Characteristic	Symbol	Rating		Unit	
		TLP620	TLP620-2 TLP620-4		
LED	Forward current	I _F (RMS)	60	50	mA
	Forward current derating	ΔI _F / °C	-0.7 (Ta ≥ 39°C)	-0.5 (Ta ≥ 25°C)	mA / °C
	Pulse forward current	I _{FP}	1 (100μs pulse, 100pps)		A
	Power dissipation (1 circuit)	P _D	100	70	mW
	Power dissipation derating	ΔP _D / °C	-1.0	-0.7	mW / °C
	Junction temperature	T _j	125		°C
Detector	Collector-emitter voltage	V _{CEO}	55		V
	Emitter-collector voltage	V _{ECO}	7		V
	Collector current	I _C	50		mA
	Collector power dissipation (1 circuit)	P _C	150	100	mW
	Collector power dissipation derating (1 circuit) (Ta ≥ 25°C)	ΔP _C / °C	-1.5	-1.0	mW / °C
	Junction temperature	T _j	125		°C
Storage temperature range	T _{stg}	-55~125		°C	
Operating temperature range	T _{opr}	-55~100		°C	
Lead soldering temperature	T _{sold}	260 (10s)		°C	
Total package power dissipation	P _T	250	150	mW	
Total package power dissipation derating (Ta ≥ 25°C, 1 circuit)	ΔP _T / °C	-2.5	-1.5	mW / °C	
Isolation voltage	BV _S	5000 (AC, 1 min., RH ≤ 60%)		V _{rms}	

Recommended Operating Conditions

Characteristic	Symbol	Min.	Typ.	Max.	Unit
Supply voltage	V_{CC}	—	5	24	V
Forward current	I_F (RMS)	—	16	20	mA
Collector current	I_C	—	1	10	mA
Operating temperature	T_{opr}	-25	—	85	°C

Individual Electrical Characteristics ($T_a = 25^\circ\text{C}$)

Characteristic		Symbol	Test Condition	Min.	Typ.	Max.	Unit
LED	Forward voltage	V_F	$I_F = \pm 10\text{mA}$	1.0	1.15	1.3	V
	Forward current	I_F	$V_F = \pm 0.7\text{V}$	—	2.5	20	μA
	Capacitance	C_T	$V = 0, f = 1\text{MHz}$	—	60	—	pF
Detector	Collector-emitter breakdown voltage	$V_{(BR)CEO}$	$I_C = 0.5\text{mA}$	55	—	—	V
	Emitter-collector breakdown voltage	$V_{(BR)ECO}$	$I_E = 0.1\text{mA}$	7	—	—	V
	Collector dark current	I_{CEO}	$V_{CE} = 24\text{V}$	—	10	100	nA
			$V_{CE} = 24\text{V}, T_a = 85^\circ\text{C}$	—	2	50	μA
Capacitance (collector to emitter)	C_{CE}	$V_{CE} = 0, f = 1\text{MHz}$	—	10	—	pF	

Coupled Electrical Characteristics ($T_a = 25^\circ\text{C}$)

Characteristic	Symbol	Test Condition	Min.	Typ.	Max.	Unit
Current transfer ratio	I_C / I_F	$I_F = \pm 5\text{mA}, V_{CE} = 5\text{V}$ Rank GB	50	—	600	%
			100	—	600	
Saturated CTR	I_C / I_F (sat)	$I_F = \pm 1\text{mA}, V_{CE} = 0.4\text{V}$ Rank GB	—	60	—	%
			30	—	—	
Collector-emitter saturation voltage	V_{CE} (sat)	$I_C = 2.4\text{mA}, I_F = \pm 8\text{mA}$ $I_C = 0.2\text{mA}, I_F = \pm 1\text{mA}$ Rank GB	—	—	0.4	V
			—	0.2	—	
			—	—	0.4	
Off-state collector current	I_C (off)	$V_F = \pm 0.7\text{V}, V_{CE} = 24\text{V}$	—	1	10	μA
CTR symmetry	I_C (ratio)	$I_C (I_F = -5\text{mA}) / I_C (I_F = +5\text{mA})$	0.33	1	3	—

Isolation Characteristics (Ta = 25°C)

Characteristic	Symbol	Test Condition	Min.	Typ.	Max.	Unit
Capacitance input to output	C _S	V _S = 0, f = 1MHz	—	0.8	—	pF
Isolation resistance	R _S	V _S = 500V	1×10 ¹²	10 ¹⁴	—	Ω
Isolation voltage	BV _S	AC, 1 minute	5000	—	—	V _{rms}
		AC, 1 second, in oil	—	10000	—	
		DC, 1 minute, in oil	—	10000	—	V _{dc}

Switching Characteristics (Ta = 25°C)

Characteristic	Symbol	Test Condition	Min.	Typ.	Max.	Unit
Rise time	t _r	V _{CC} = 10V I _C = 2mA R _L = 100Ω	—	2	—	μs
Fall time	t _f		—	3	—	
Turn-on time	t _{on}		—	3	—	
Turn-off time	t _{off}		—	3	—	
Turn-on time	t _{ON}	R _L = 1.9kΩ V _{CC} = 5V, I _F = ±16mA (Fig.1)	—	2	—	μs
Storage time	t _s		—	15	—	
Turn-off time	t _{OFF}		—	25	—	

Fig. 1 Switching time test circuit

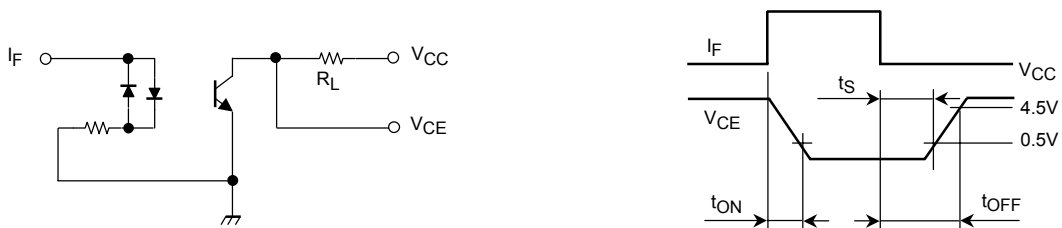

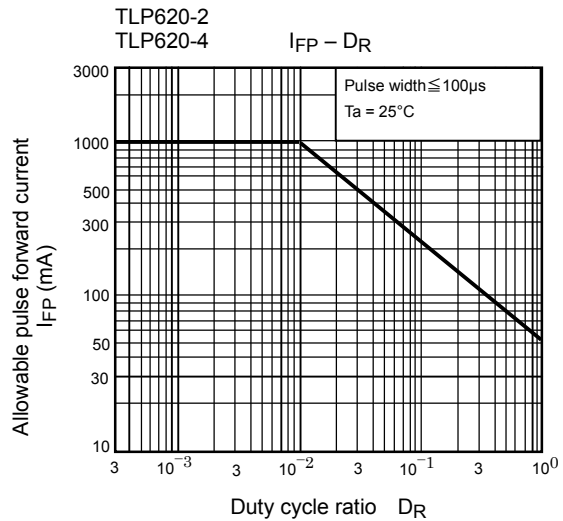
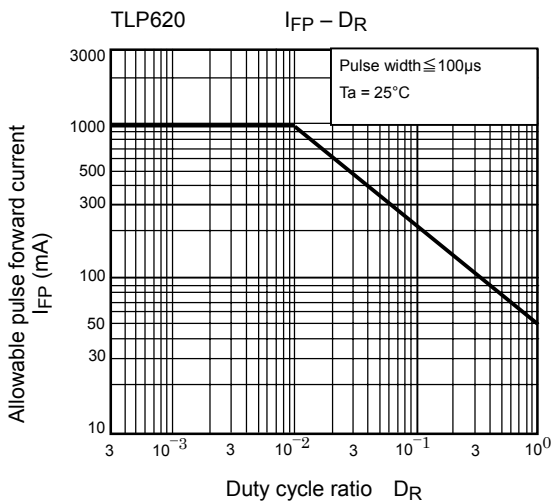
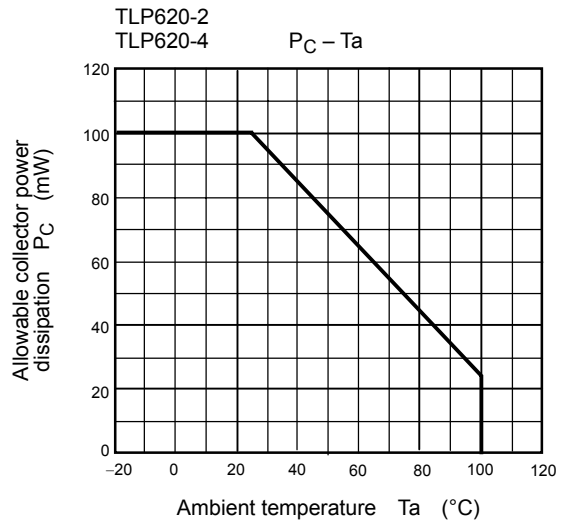
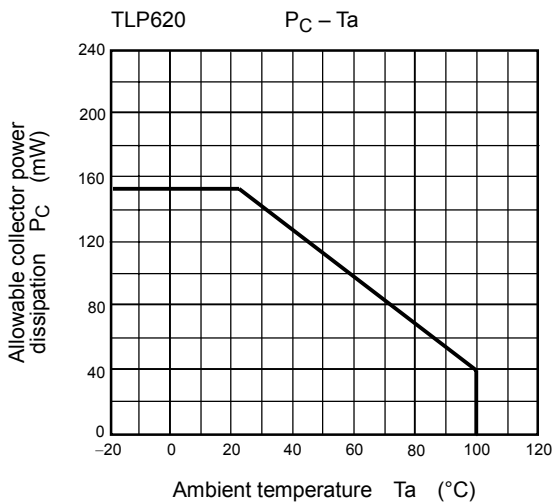
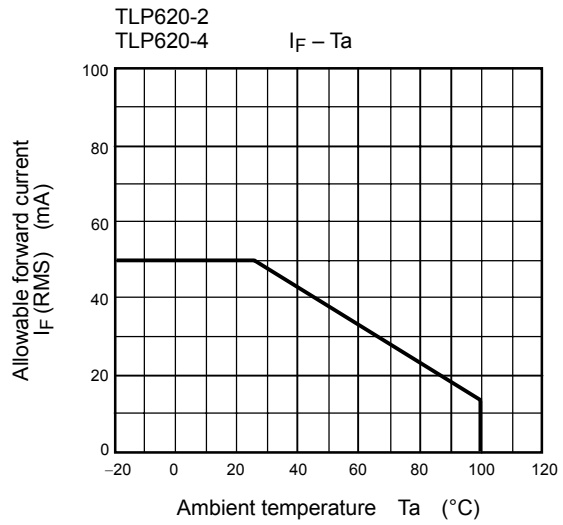
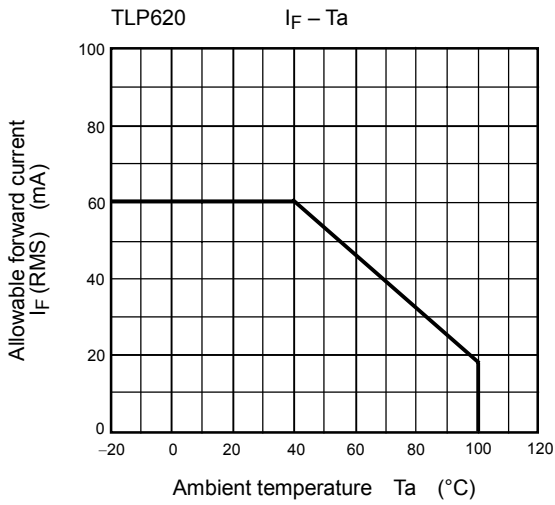

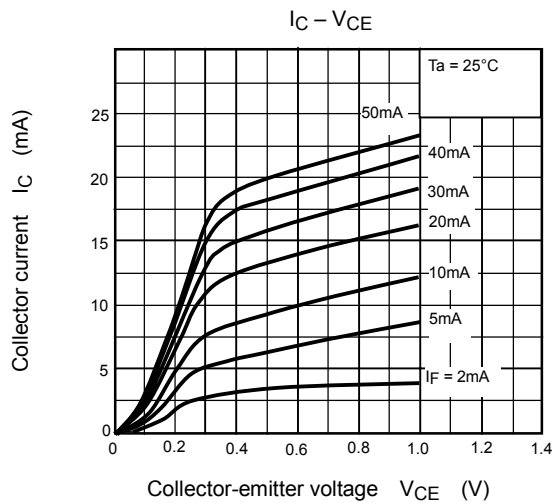
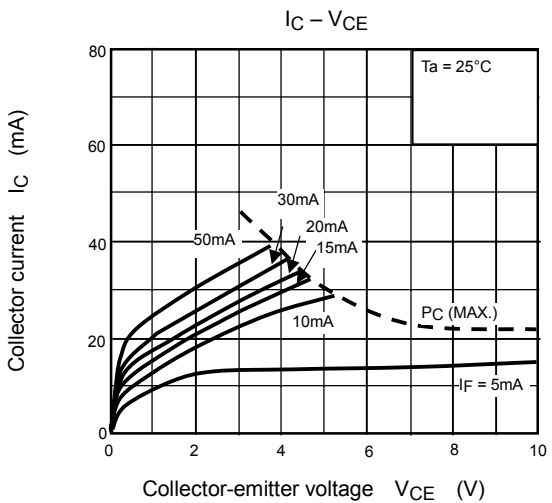
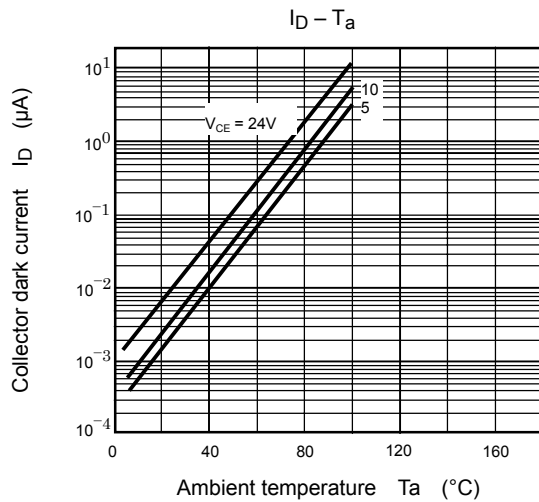
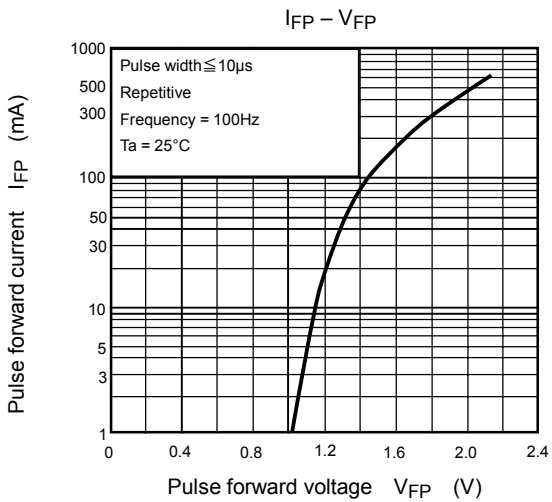
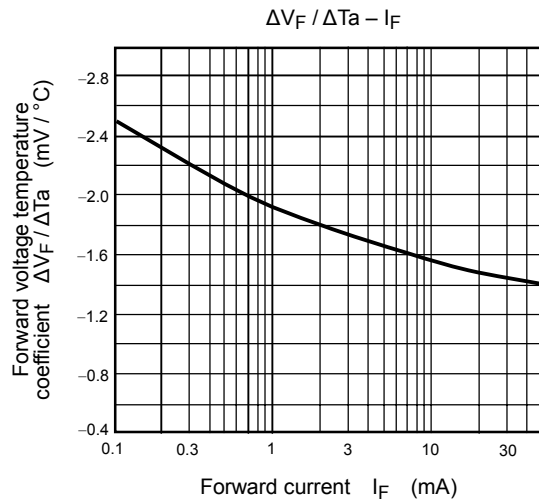
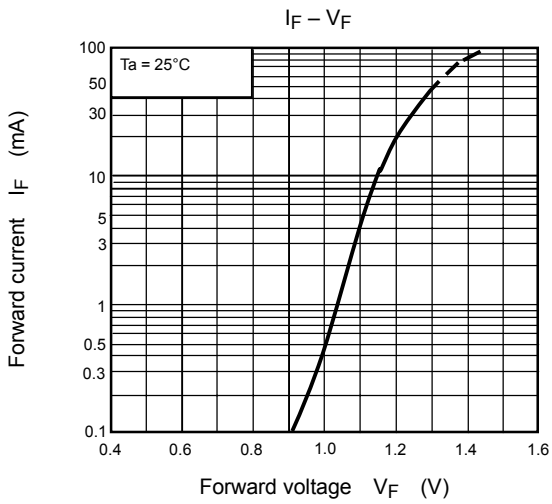

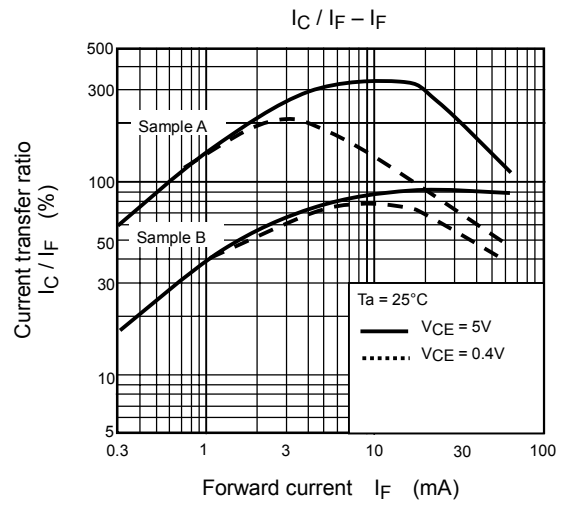
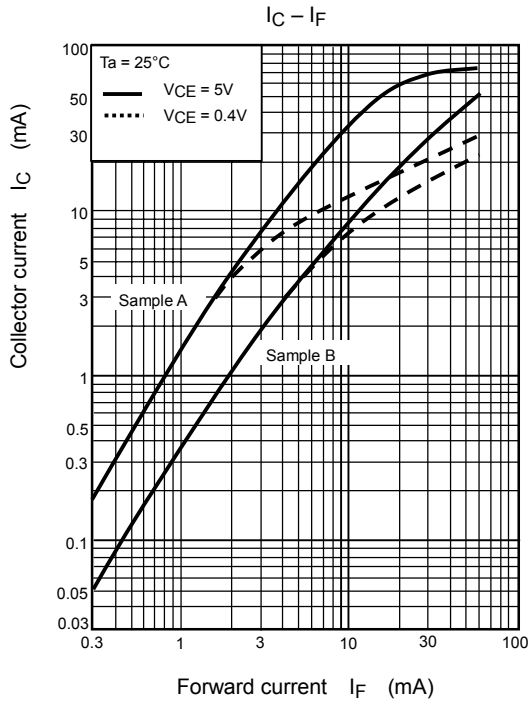
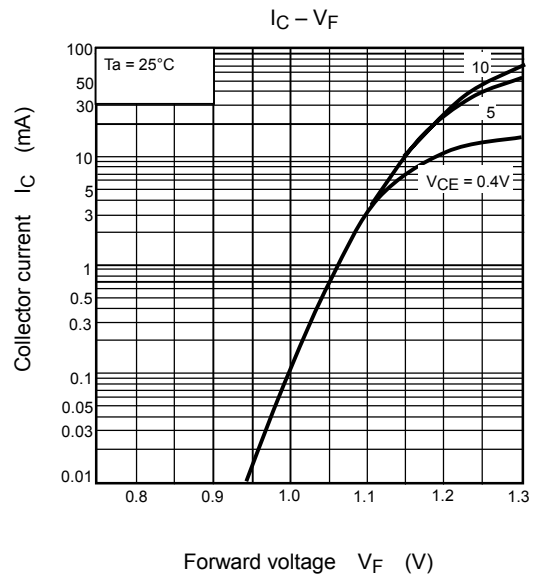
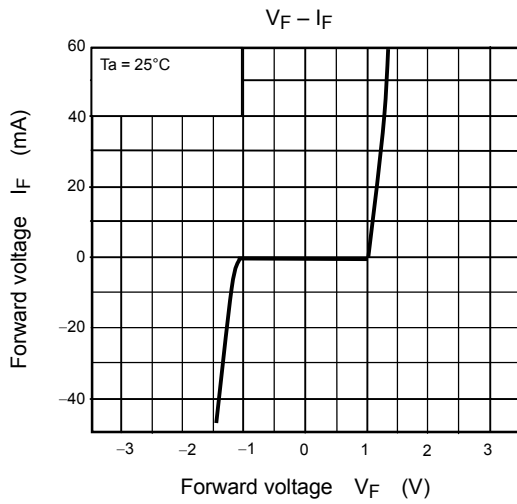

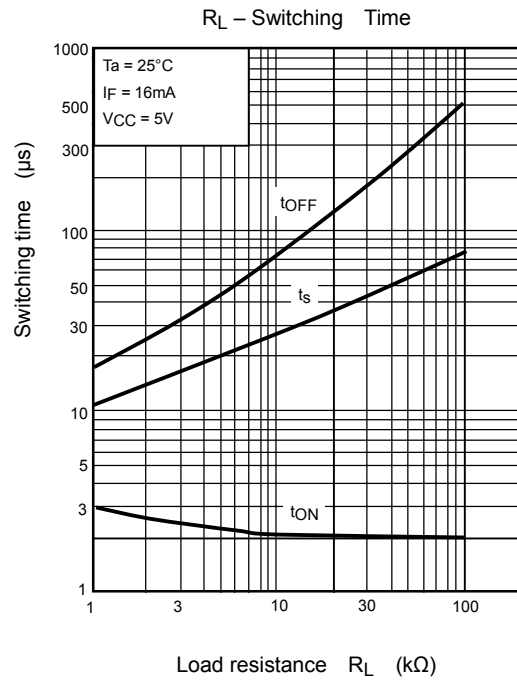
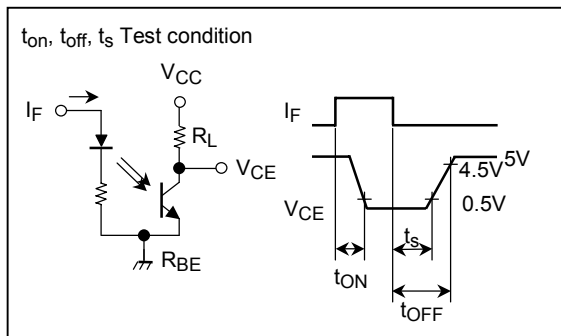
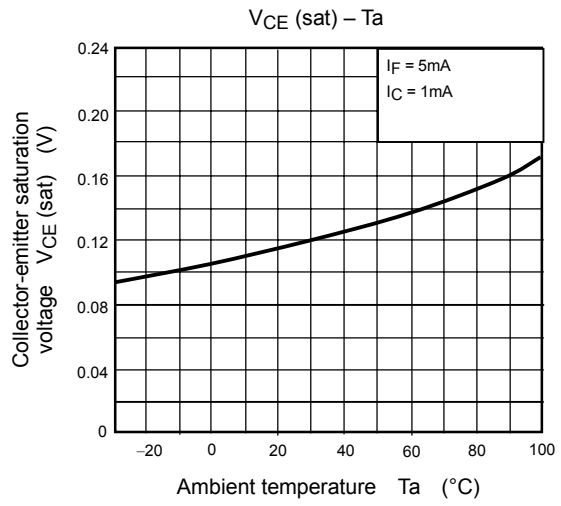
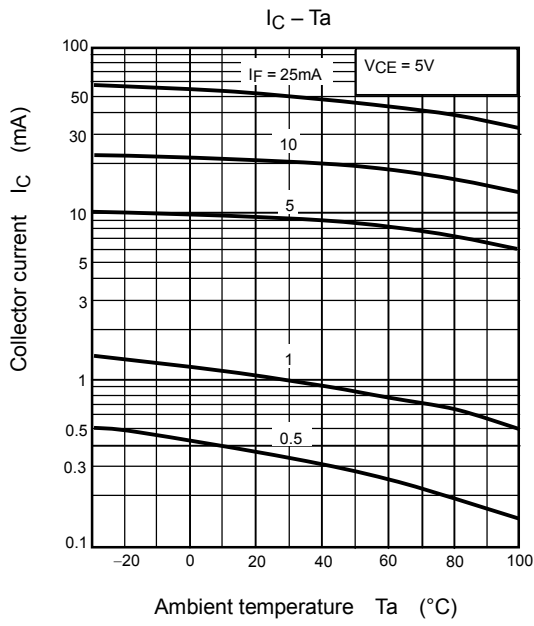

RESTRICTIONS ON PRODUCT USE

000707EBC

- TOSHIBA is continually working to improve the quality and reliability of its products. Nevertheless, semiconductor devices in general can malfunction or fail due to their inherent electrical sensitivity and vulnerability to physical stress. It is the responsibility of the buyer, when utilizing TOSHIBA products, to comply with the standards of safety in making a safe design for the entire system, and to avoid situations in which a malfunction or failure of such TOSHIBA products could cause loss of human life, bodily injury or damage to property.
In developing your designs, please ensure that TOSHIBA products are used within specified operating ranges as set forth in the most recent TOSHIBA products specifications. Also, please keep in mind the precautions and conditions set forth in the "Handling Guide for Semiconductor Devices," or "TOSHIBA Semiconductor Reliability Handbook" etc..
- The TOSHIBA products listed in this document are intended for usage in general electronics applications (computer, personal equipment, office equipment, measuring equipment, industrial robotics, domestic appliances, etc.). These TOSHIBA products are neither intended nor warranted for usage in equipment that requires extraordinarily high quality and/or reliability or a malfunction or failure of which may cause loss of human life or bodily injury ("Unintended Usage"). Unintended Usage include atomic energy control instruments, airplane or spaceship instruments, transportation instruments, traffic signal instruments, combustion control instruments, medical instruments, all types of safety devices, etc.. Unintended Usage of TOSHIBA products listed in this document shall be made at the customer's own risk.
- Gallium arsenide (GaAs) is a substance used in the products described in this document. GaAs dust and fumes are toxic. Do not break, cut or pulverize the product, or use chemicals to dissolve them. When disposing of the products, follow the appropriate regulations. Do not dispose of the products with other industrial waste or with domestic garbage.
- The products described in this document are subject to the foreign exchange and foreign trade laws.
- The information contained herein is presented only as a guide for the applications of our products. No responsibility is assumed by TOSHIBA CORPORATION for any infringements of intellectual property or other rights of the third parties which may result from its use. No license is granted by implication or otherwise under any intellectual property or other rights of TOSHIBA CORPORATION or others.
- The information contained herein is subject to change without notice.